

PART XV

ROUTING: INSIDE AN AUTONOMOUS SYSTEM (RIP, OSPF, HELLO)

Static Vs. Dynamic Interior Routes

- Static routes
 - Initialized at startup
 - Never change
 - Typical for host
 - Sometimes used for router
- Dynamic router
 - Initialized at startup
 - Updated by route propagation protocols
 - Typical for router
 - Sometimes used in host

Illustration Of Topology In Which Static Routing Is Optimal

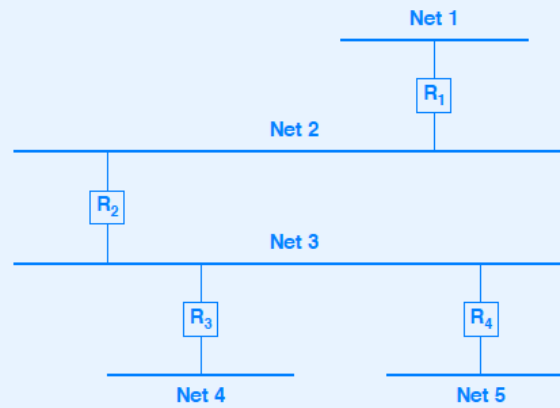

- Only one route exists for each destination

Illustration Of Topology In Which Dynamic Routing Is Needed

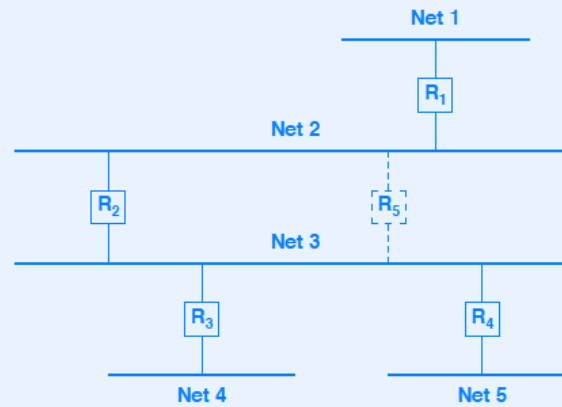

- Additional router introduces multiple paths

Exchanging Routing Information Within An Autonomous System

- Mechanisms called interior gateway protocols, IGPs
- Choice of IGP is made by autonomous system
- Note: if AS connects to rest of the world, a router in the AS must use an EGP to advertise network reachability to other autonomous systems.

Example Of Two Autonomous Systems And the Routing Protocols Used

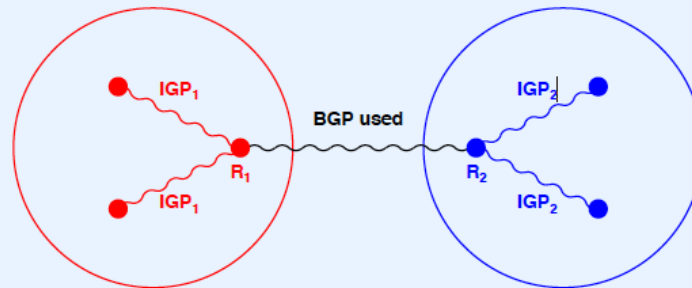

Example IGPs

- RIP
- HELLO
- OSPF

Routing Information Protocol (RIP)

- Implemented by UNIX program *routed*
- Uses hop count metric
- Distance-vector protocol
- Relies on broadcast
- Assumes low-delay local area network
- Uses split horizon and poison reverse techniques to solve inconsistencies
- Current standard is RIP2

Two Forms Of RIP

- Active
 - Form used by routers
 - Broadcasts routing updates periodically
 - Uses incoming messages to update routes
- Passive
 - Form used by hosts
 - Uses incoming messages to update routes
 - Does not send updates

Illustration Of Hosts Using Passive RIP

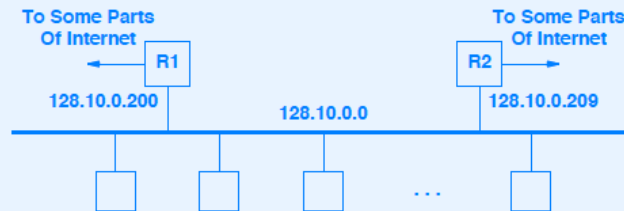

- Host routing table initialized to:

Destination	Route
128.10.0.0 default	direct 128.10.0.200

- Host listens for RIP broadcast and uses data to update table
- Eliminates ICMP redirects

RIP Operation

- Each router sends update every 30 seconds
- Update contains pairs of
(destination address, distance)
- Distance of 16 is *infinity* (i.e., no route)

Slow Convergence Problem (Count To Infinity)

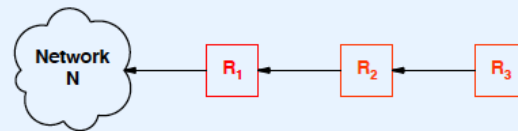

Routers with routes to network N

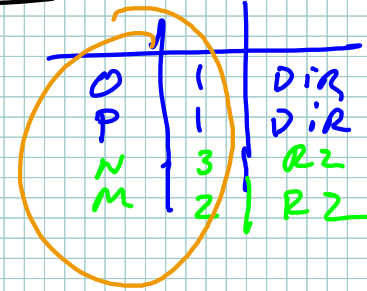
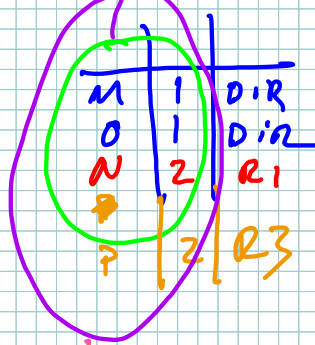
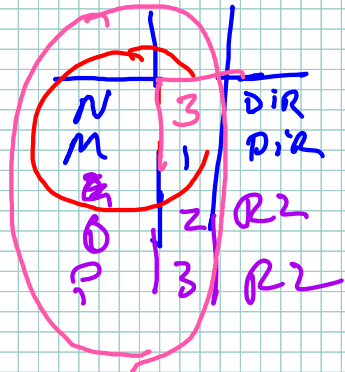
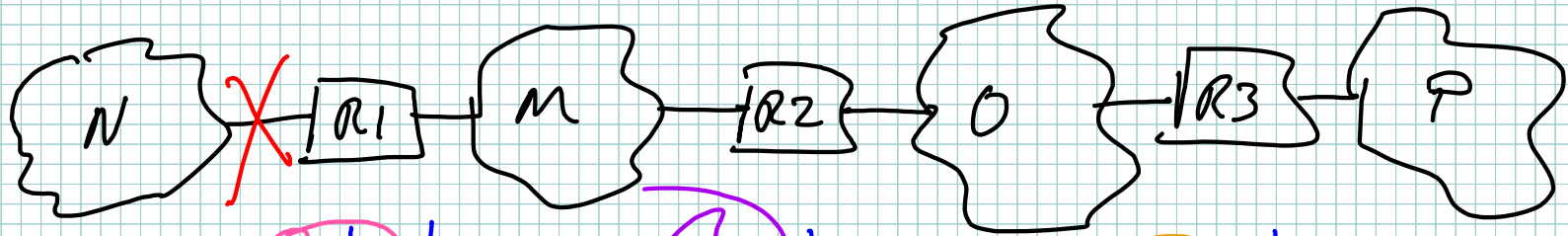

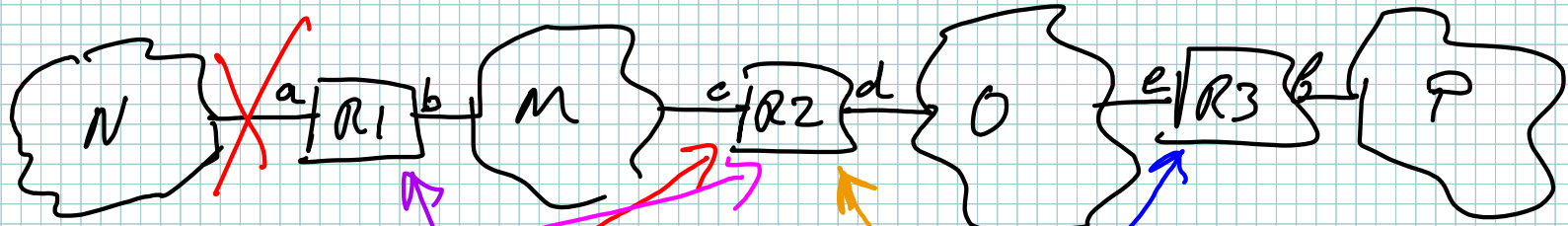

N	16	dir	a
M	5	dir	b
O	2	R2	b
P	3	R2	b

M	1	dir	c
O	1	dir	d
N	16	R1	c
P	2	R3	d

O	1	dir	e
P	1	dir	e
M	1	R2	e
N	16	R2	e

Slow Convergence Problem (Count To Infinity)

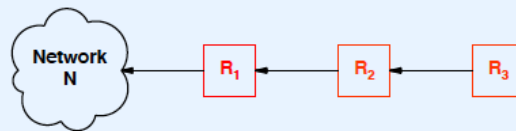

Routers with routes to network N

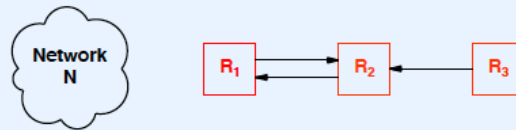

R₁ erroneously routes to R₂ after failure

RIP1 Update Format

0	8	16	31
COMMAND	VERSION (1)	RESERVED	
FAMILY OF NET 1		NET 1 ADDR., OCTETS 1 - 2	
NET 1 ADDRESS, OCTETS 3 - 6			
NET 1 ADDRESS, OCTETS 7 - 10			
NET 1 ADDRESS, OCTETS 11 - 14			
DISTANCE TO NETWORK 1			
FAMILY OF NET 2		NET 2 ADDR., OCTETS 1 - 2	
NET 2 ADDRESS, OCTETS 3 - 6			
NET 2 ADDRESS, OCTETS 7 - 10			
NET 2 ADDRESS, OCTETS 11 - 14			
DISTANCE TO NETWORK 2			
...			

- Uses *FAMILY* field to support multiple protocols
- IP address sent in octets 3 - 6 of address field
- Message travels in UDP datagram

Changes To RIP In Version 2

- Update includes subnet mask
- Authentication supported
- Explicit next-hop information
- Messages can be multicast (optional)
 - IP multicast address is 224.0.0.9

RIP2 Update Format

0	8	16	31
COMMAND	VERSION (1)	UNUSED	
FAMILY OF NET 1		ROUTE TAG FOR NET 1	
NET 1 IP ADDRESS			
NET 1 SUBNET MASK			
NET 1 NEXT HOP ADDRESS			
DISTANCE TO NETWORK 1			
FAMILY OF NET 2		ROUTE TAG FOR NET 2	
NET 2 IP ADDRESS			
NET 2 SUBNET MASK			
NET 2 NEXT HOP ADDRESS			
DISTANCE TO NETWORK 2			
...			

- Packet format is backward compatible
- Infinity still limited to *16*
- RIP2 *can* be broadcast

Measures Of Distance That Have Been Used

- Hops
 - Zero-origin
 - One-origin (e.g., RIP)
- Delay
- Throughput
- Jitter

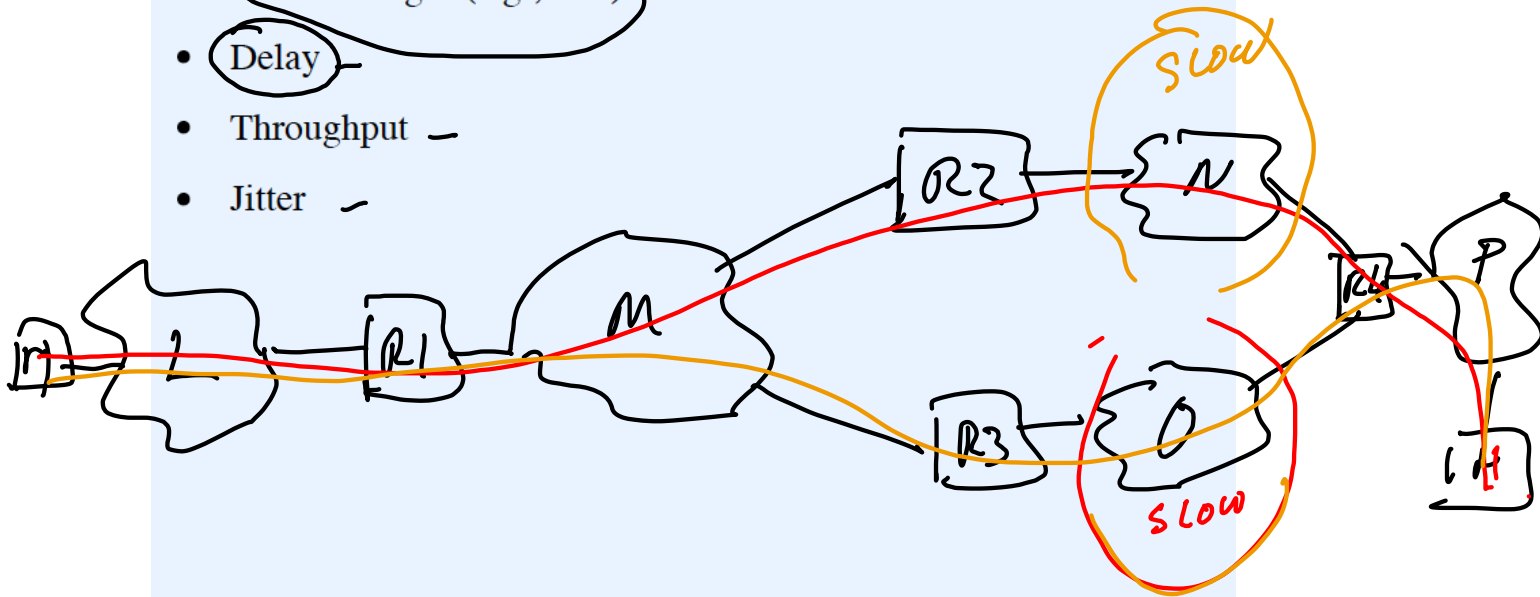

HELLO: A Protocol That Used Delay

- Developed by Dave Mills
- Measured delay in milliseconds
- Used by NSFNET fuzzballs
- Now historic

How HELLO Worked

- Participants kept track of delay between pairs of routers
- HELLO propagated delay information across net
- Route chosen to minimize total delay

Route Oscillation

- Effective delay depends on traffic (delay increases as traffic increases)
- Using delay as metric means routing traffic where delay is low
- Increased traffic raises delay, which means route changes
- Routes tend to oscillate

Why HELLO Worked

- HELLO used only on NSFNET backbone
- All paths had equal throughput
- Route changes damped to avoid oscillation

Open Shortest Path First (OSPF)

- Developed by IETF in response to vendors' proprietary protocols
- Uses SPF (link-state) algorithm
- More powerful than most predecessors
- Permits hierarchical topology
- More complex to install and manage

OSPF Features

- Type of service routing
- Load balancing across multiple paths
- Networks partitioned into subsets called *areas*
- Message authentication
- Network-specific, subnet-specific, host-specific, and CIDR routes
- Designated router optimization for shared networks
- Virtual network topology abstracts away details
- Can import external routing information

OSPF Message Header

0	8	16	24	31
VERSION (1)	TYPE	MESSAGE LENGTH		
SOURCE ROUTER IP ADDRESS				
AREA ID				
CHECKSUM		AUTHENTICATION TYPE		
AUTHENTICATION (octets 0-3)				
AUTHENTICATION (octets 4-7)				

- Each message starts with same header

OSPF Message Types

Type	Meaning
1	Hello (used to test reachability)
2	Database description (topology)
3	Link status request
4	Link status update
5	Link status acknowledgement

OSPF HELLO Message Format

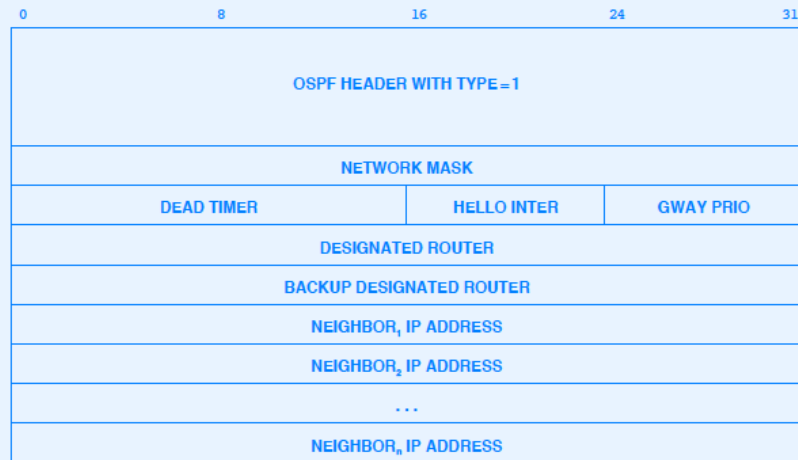

- Used to test reachability

OSPF Database Description Message Format

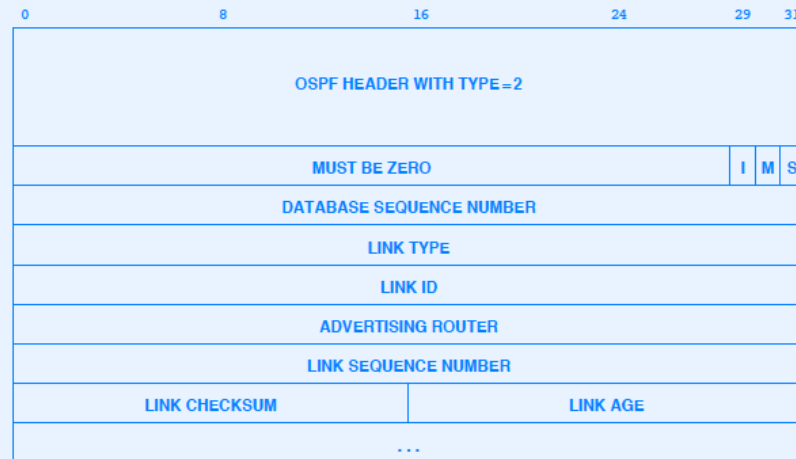

- Fields starting at *LINK TYPE* are repeated

Values In The LINK Field

Link Type	Meaning
1	Router link
2	Network link
3	Summary link (IP network)
4	Summary link (link to border router)
5	External link (link to another site)

OSPF Link Status Request Message Format

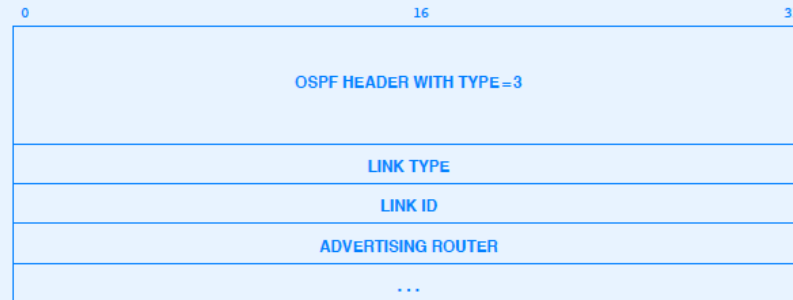

OSPF Link Status Update Message Format



Header Used In OSPF Link Status Advertisements

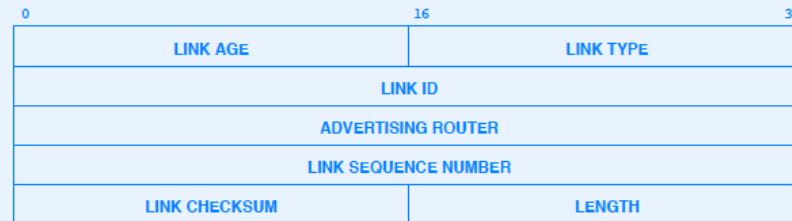

- Four possible formats follow
 - Links from a router to given area
 - Links from a router to physical net
 - Links from a router to physical nets of a subnetted IP network
 - Links from a router to nets at other sites

Discussion Question

- What are the tradeoffs connected with the issue of routing in the presence of partial information?

Summary

- Interior Gateway Protocols (IGPs) used within an AS
- Popular IGPs include
 - RIP (distance vector algorithm)
 - OSPF (link-state algorithm)